



PRIDE[®]

MOBILITY
LIVE YOUR BEST[®]

www.pridemobility.eu



OWNER'S MANUAL



SUNGO Europe B.V.
Fascinatio Boulevard 522, Unit 1.7, 2909VACapelle aan den IJssel, The Netherlands

PRIDE[®]
MOBILITY
LIVE YOUR BEST[®]
www.pridemobility.eu
www.quantumrehab.eu

CONTENTS-----1

I. INTRODUCTION-----2

II. ATTENTION-----3-4

III. STRUCTURE AND PERFORMANCE-----5-7

IV. ASSEMBLY/FOLDING/DEBUG-----8-10

V. OPERATION-----11-14

VI. MAINTENANCE-----15-16

VII. WARRANTY-----17



Manufactured by INNUOVO, distributed by Pride Mobility
 WARNING: Please read the user manual before operating this scooter

Manufacture By :
 Zhejiang Innuovo Rehabilitation Devices Co.,Ltd
 No. 196 Industry Road, Hengdian Movie Zone,
 Dongyang, Zhejiang, China.
 TEL: 86-0579-89302863
 FAX:86- 0579-89327233

Distributed By:
 Pride Mobility Products Europe BV.
 De Zwaan 3,1601MS Enkhuizen,
 the Netherlands
 Tel:0031(0)85-0408630
 Fax:0031(0)85-0430039
<http://quantumrehab.eu/>

Read and follow all instructions, warnings, and notes in this manual before attempting to operate your power wheelchair for the first time. If there is any information in this manual which you do not understand, or if you require additional assistance for assembly or operation, please contact with your authorized local provider.

These symbols below in this manual are used to identify warnings and important information. All of them are very important to your safety. It is strongly recommended that you should read and understand them completely.

	WARNING! Failure to heed the warnings in the manual may result in personal injury.
	ATTENTION! Failure to heed the cautions in the manual may result in damage to the powered wheelchair.

I. Introduction

This product is completely made from high quality aluminum alloy material, and its overall weight is only 19.8kg(without battery). Especially, its structure for quick disassembly and assembly are very convenient for you to store or place at the trunk of your vehicle while traveling. We are certain that the design features, excellent performance and trouble -free operation of this product will ensure your daily life more convenient.

This product is suitable for all disabled people, the elderly and the infirm who have difficulty with walking. The user's maximum weight is 100kg. This product is Model N5513.

This product falls in the indoor product category, and is suitable for indoor use and the flat streets near buildings, but not grass, gravel, or a slope of more than 6 degrees. The product is also not made for moving walkways, and also not for rainy days.

Please note:

This power chair is an electrical, non-aseptic, reusable product without chemical substances

The safety and durability of this product depends not only on the structural strength of products, but also on the user usage and use of the product environment, user habits, whether the periodic maintenance, maintenance and other factors are followed .

Our products are warranted from the date of production for 7 years. (production date on inspection certificate).

2.1 Instructions before using

2.1.1 If the user manual is not completely read and understood, please do not drive.

2.1.2 The maximum loading capacity is 100kg, please do not drive overloaded . And it is for single use, please do not carry passengers.

2.1.3 Please do not drive after consuming alcohol or when tired.

2.1.4 Do not drive at night or in the case of an unclear line of sight.

2.1.5 Please self-test before driving and refer to the manual section 5.3 "Commissioning" and 6.2.1 "Practice before operation " if driving for the first time.

2.1.6 This chair is not waterproof, do not expose in rain and snow as well as driving in rain or snow.

2.2 Notices for use

2.2.1 This power chair can drive on a good smooth surface, but will not perform optimal on muddy, soft, or icy roads.

2.2.2 This power chair has the ability of riding over a ditch or obstacle,when doing this you should reduce the speed and travel slowly.

2.2.3 This power chair can climb slopes of maximum 6°.

2.2.4 Please avoid driving in the crowds, traffic and other places with heavy traffic.

2.2.5 Please ensure that the motor lock lever in "Electric" position, chair is on electric mode.

2.2.6 Please ensure that the controller system fixed well, joystick is straight and correct. Sit comfortably and fasten the lap belt. Sit back against the backrest, this helps with stability on uneven roads. 2.2.7 Press the on/off button, firstly check whether the current fastest speed setting is appropriate for your operating proficiency, or it should be adjusted for safety. We recommend that the user should drive slowly in the beginning for every use, and gradually speed up.



WARNING!

If your wheelchair moves accidentally, please immediately release the joystick so that the wheelchair will stop moving automatically. If the joystick is malfunctioning and the brakes don't respond, please cut off the power.

2.3 Electromagnetic interference

Your wheelchair may be traveling in the areas affected by electromagnetic interference from some radio transmitters such as radio, wireless intercom, mobile phones and radars etc. In these cases, your wheelchair's driving may be affected by them.



WARNING! Electronic equipment can be affected by Electro-Magnetic Interference(EMI). Such interference may be from radio stations, TV stations, mobile phones and other radio transmitters. If the wheelchair exhibits abnormal situations due the wheelchair, and consult your service agent. We accepts no legal liability for losses of any kind arising from failure to comply with this condition.

3.STRUCTURE AND PERFORMANCE

3.1 Power chair consists of several parts mainly (figure 1):

Chair-Frame: It consists of a foldable component, which can be folded from the seatbase's middle in order to store or transport conveniently.

Joystick: It has the function of moving forward, back, turning, speed adjustment and etc.

Battery Box: It is located in the square tube of both sides. Each side has one lithium battery of 24 Volt and 6.6AH/10AH with overload protectors. There are two charger sockets for the batteries, one is under the controller and another is on the upper of the battery box. They supply the power for motors.

Rear wheel: The rear wheels are connected to the motors, used to drive the wheelchair.

Front wheel: to support the wheelchair and keep it safe and steady.



figure 1

3.2 Product characteristics of the electric wheelchair

Classification according to prevent electric shock type : internal power supply

Classification according to prevent electric shock level : type B applied part Wheelchairs are non-AP or APG-type device.

Classification according to the operation pattern classification: run continuously.

The power of the equipment : internal power DC 24V

3.3 ELECTRICAL DIAGRAM OF MODEL 5513

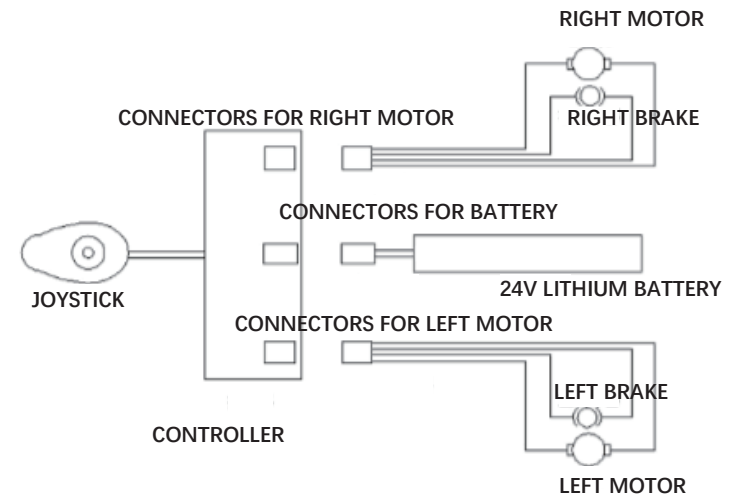

SPECIFICATION

Overall Dimensions	900mmX600mmX880mm
Seat Height	500mm
Seat Width	400mm
Seat Depth	410mm
Arm Height	210mm
Seatback Height	420mm
Battery Weight	1.4kg
Wheelchair Weight	19.8kg without battery
Maximum Speed	4.5km/h
Braking Distance(on a level surface)	≤1000mm
Minimum Turning Radius	900mm
Weight Capacity	100kg
Theoretical Travel Range	10km
Static Stability	≥6°
Dynamic Stability	≥3°
Slope Performance	≥6°
Climing Ability	≥3°
Motor Type	24V/200W*2
Lithium Battery Type	<input type="checkbox"/> 24V6.6AH*2 <input type="checkbox"/> 24V10AH*2
Max. Output Current of Controller	35A
Max. Output Current of Charger	2A
Front Wheel	Solid tire, Outside size of 178mm
Rear Wheel	Solid tire, Outside size of 216mm

5.1 Installation

5.1.1 Take out the wheelchair from the packing box and put it on the ground. Push the backrest and footrest back and forth respectively by two hands (figure 2). When you hear a click, the locating pins are inserted into the positioning holes, and in this case, the chair frame has been completely opened.

5.1.2 Fold down the armrest forward (figure 4).

5.1.3 Put the controller on the armrest (figure 5). And then pull down the tightening spanner on the controller to fasten the controller. (figure 6)

5.1.4 Turn over the wheelchair, press the stopper pins down to release legs (figure 7) and pull out the anti-tipper until a location pin automatically lock the anti-tipper (figure 8).

5.1.5 Take out the foam pads from the battery boxes, and then put the two batteries separately into the right and left boxes (figure 9). Note that the batteries should be fully inserted in the end (figure 10).

5.1.6 Fold down the footrest forward completely (figure 12).

5.1.7 Switch the motor lock levers on the motors to the "Electric" mode (figure 11).

5.1.8 Now, your wheelchair has been completely assembled, and can be used.



figure 2



figure 4



figure 5

CAUTION!

1. Make sure that the locating pins have been inserted into the positioning holes when the wheelchair has been fully folded open, and then it can be used.
2. Make sure that the anti-tippers are fully pulled out in order to prevent the wheelchair back from tipping over, which may result in personal injury.
3. Batteries must be fully inserted.



figure 8

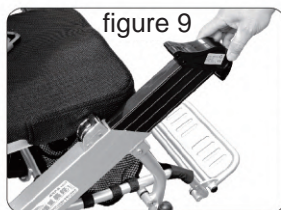

figure 9

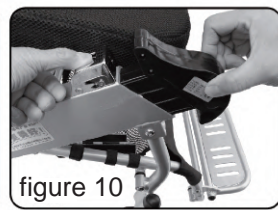

figure 10

5.2 Folding

The wheelchair is foldable in order to reduce its bulk for transportation and storage.

1. Turn off the power.
2. Switch the motor lock levers to drive mode to make sure that the wheelchair has not been in manual mode (figure 11).
3. Turn the footrest upward (figure 12)
4. Press the buttons on both sides of seatback by your forefingers to fold down the backrest (figure 13)
5. Pinch inward two thumb-levers of the right and left locating pins at the back of the backrest (figure 14).
6. Pull up the footrest frame (figure 15) so that the chair frame will be fully folded (figure 16). Turn back the armrest. (figure 17).



figure 6



figure 7

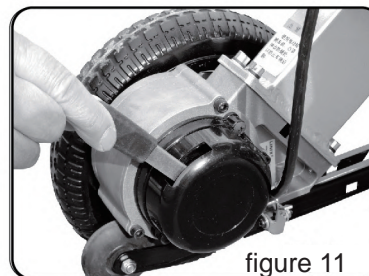

figure 11



figure 12

For ease of use, the wheelchair is equipped with two motor lock levers, when you press down the motor lock lever to "manual", the wheelchair will be in manual mode, and can be pushed by hand. When the motor lock lever is pressed upward to "electric", the wheelchair will be on electric mode, and can't be moved by hand (figure 11).

5.3 Debugging

- 5.3.1 When the motor lock lever is downward to manual mode, do not move the chair by hands; when the motor lock lever is upward to electric mode, do not move the chair by hands.
- 5.3.2 Press the joystick power, and the battery indicate light will be on.
- 5.3.3 Rotate the joystick lever toward front to the end, observe the rotation of wheelchair wheels, and then rotate other direction to observe if the wheels run.
- 5.3.4 Release the joystick lever, it will come back to the middle position, then you observe the wheels should be stopped.

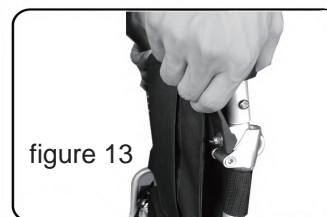

figure 13

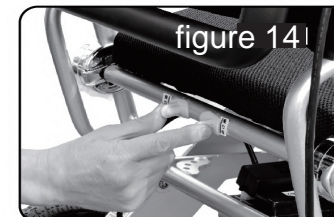

figure 14

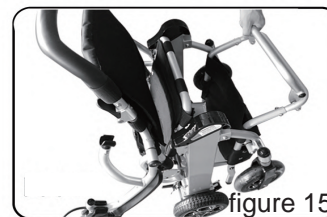

figure 15



figure 16

6. USE, OPERATION

6.1 Use

6.1.1 Controller: It is the key component of a wheelchair. All electronics to operate the latter are housed in it (figure 18). Usually the controller is installed in one armrest, which is connected with motor and battery on power box.

On/off button: this button supplies the power for the electronic components of the control system, the control system supplies the power to the motors of the wheelchair. Do not use the on/off button to stop the chair unless there's an emergency situation. Otherwise it may shorten the life of the wheelchair drive components.

Joystick: The joystick is mainly used to control the wheelchair's movement including its speed and direction (forward, backward and left or right etc). The further you push the joystick from its central position, the faster the wheelchair moves. Whenever you release the joystick, it will automatically go back to the center and the brake will be automatically operative to stop the wheelchair.

Horn button: The horn will sound if you press this button.

Speed Up/Down Buttons and Speedometer: After turning on the power, the speedometer shows the current maximum speed setting. This maximum speed setting can be adjusted through the speed up button or speed down button by user.

Charger Socket: There are only used to this wheelchair. Do not use the sockets to supply to other electrical equipment. Otherwise, it may damage the wheelchair's control system and its E.M.C

WARNING!



If your wheelchair moves accidentally, please immediately release the joystick so that the wheelchair will stop moving automatically unless the joystick is out of order.

CAUTION!



If you connect any device other than the supplied battery charger into the charger socket on the wheelchair. It could cause permanent damage to the product.



6.1.2 Batteries and Its Usage

Fully charge your new battery prior to its initial use. This brings the battery up to about 90% of its peak performance level; Give the battery another full charge of 8-14 hours and operate your wheelchair again, the batteries will perform at over 90% of their potential; After four or five charging cycles, the batteries will be used by 100% and the life time will be extended. Please replace the battery when the battery fails. The old battery must be returned to supplier because of environmental pollution.



CAUTION!

The wheelchair won't work optimal when the environment temperature is less than minus 10 C° or above 50 C°.

6.1.3 Charging Batteries

The batter charger is an important part of the wheelchair. The off-board charger attached to this product can charge its batteries quickly and easily to make your wheelchair the best.



CAUTION!

The charge of 24V/2A supplied by this company meets the requirements mentioned in Section I (《General Safety Requirements》) of medical electrical equipment GB9706.1-2007. Please be sure to use the charger we supplied and do not use the other chargers.

Charging the batteries using the off-board charger supplied by us:

- Be certain the controller is powered off and the wheelchair is in the drive mode, instead of the manual mode.
- Connect the 3-pin output plug of the charger to the controller.
- Connect the power plug of the charger to the standard wall outlet.
- The red LED on the charger lights indicating that charging is in progress. The green LED on the charger lights when the batteries are fully charged.
- We recommend you that the batteries should be charged for 8-12 hours.
- Remove the charger and power plug when fully charged, and put them into the bag behind the seatback.

6.1.4 Circuit breaker

The circuit breaker, which is located in the battery box, is set for the wheelchair's safety. Once motors or batteries overloaded, the circuit breaker will trip to cut off the power. After one or two minutes, it will automatically reset and then you can continue to drive the wheelchair. 6.1.5 Lap belt
For your safety, the lap belt must be fastened before you drive the wheelchair.

6.2 Operation

6.2.1 Precautions for operation

- Find a spacious place like square and have an assistant to help you practice until you have enough confidence to operate it by yourself.
- Be certain to shut down the power when you transfer in- or out of the chair, and adjust the speed through speed adjustment button.
- We recommend you set the lowest speed until you can operate the electric wheelchair skillfully.
- To Practice the stop operation, forward and backward. Push the handle, the wheelchair move to anywhere you want.
- Firstly, ensure that it is the lowest speed when practice forward operation. After Skilled, you can practice "S" shaped turn. After you are familiar with "S" shaped turn, to practice backward operation, and pay attention to the speed control setting. And the backward speed should lower than forward speed.

WARNING!

Do not use your wheelchair unless getting help from your assistant when the wheelchair is in manual mode. Otherwise it may result in personal injury.



Do not set your wheelchair in manual mode by yourself while you are seated in the wheelchair. Otherwise it may result in personal injury. In this case, please ask your assistant to help you. Do not set your wheelchair in manual mode when it is on an incline. Otherwise, the wheelchair could be out of control to roll down by itself, and result in personal injury.

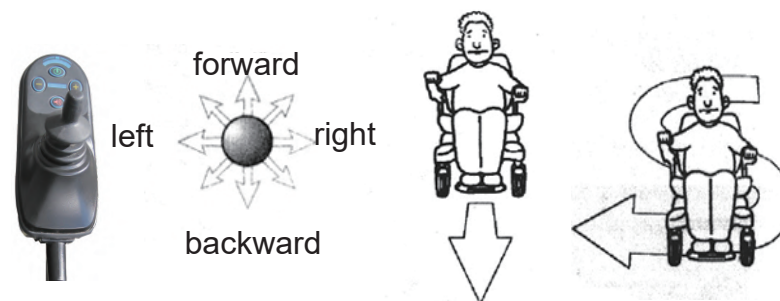

7. Fault Diagnosis and Troubleshooting

For your convenience, this product has an automatic fault warning function. Once it malfunctions, the LEDs on the controller will flash with alarm sounded by the horn. You can find where a fault is according to information in Table 2.

If the fault is still showing after checking out the fault based on that in table 2, do not use the wheelchair. Please turn off the power and consult your service agent immediately.

Beep 2+1	Communication failure	Check connection inside the joystick
Beep 2+2	Right motor failure	Check right motor or wire connection
Beep 2+3	Right brake error or cable connection poor	Check if the brake lever is in place & if the brake is damaged
Beep 2+4	Left motor failure	Check left motor or wire connection
Beep 2+5	Left brake error or cable connection poor	Check if the brake lever is in place & if the brake is damaged
Beep 2+6	Overcurrent	Check if the motor is locked or short circuit or if the joystick is damaged
Beep 2+7	Joystick lever failure	Check if the joystick lever works normally or the inside connection is loose
Beep 2+8	Joystick failure	Check with supplier for repair
Beep 2+9	Battery failure	Charge the battery, if still not work, replace a new battery with same specification

8. Safety devices and accident treatment

8.1 Circuit breaker: Refer to instruction manual 6.1.4

8.2 Safety belt: Refer to instruction manual 6.1.5

8.3 Please release the joystick whenever there is wheelchair fault, the wheelchair will be stopped.

9. Maintenance

9.1 Maintenance

Your power wheelchair also requires routine maintenance like other motorized vehicles. Some checks can be performed by yourself, but others require assistance from your service agent. Preventive maintenance is very important. If you follow the maintenance and checks in this section, your wheelchair will offer you trouble-free operation for years. If you have any doubt for your wheelchair's care or operation, please contact your service agent.

9.1.1 Humidity

Your wheelchair, like most electrical and mechanical equipments, is susceptible to external conditions. In any case, you should avoid the damp environment. Direct or prolonged exposure to water or dampness could cause the wheelchair to malfunction electronically and mechanically. Water can cause electrical components and the chair's frame to be corroded.

9.1.2 Temperature

- Some parts of your wheelchair are susceptible to temperature.
- In extremely cold temperature, the battery can be frozen.
- Temperature above 55° may cause your wheelchair's speed to be reduced.

9.1.3 General Guidelines

- Avoid beating the controller, especially the joystick.
- Avoid the exposure of your wheelchair for long time to extreme conditions, such as hot, cold or moisture environment.
- Keep the controller clean.
- Check all electric connections, including the cable and connectors of the charger, and ensure that they are all tight and secure.
- If only red LEDs on the Battery Gauge are lit, the batteries are almost out of charge. You should recharge the batteries as soon as possible.
- The frame surface has been sprayed with a clear sealant coating. You can apply a light coat of car wax to make the surface keep a high gloss.
- Check all cables. Make sure they are in good condition and are not corroded. The battery must be fully inserted in the end of the battery box.
- All wheel bearings are lubricated and sealed. There is no need to lubricate them yourself.
- Check if there are loose parts for wheel hub, drive device, and chair itself. If loose, tighten them in time.



WARNING!

Never let the battery freeze, do not charge the frozen battery, which may cause personal injury and the battery damaged.

9.1.4 Maintenance after use

- Turn off the power(It is the best to disconnect all the connectors.)
- Prevent children and unfit people from using the wheelchair.
- Store the wheelchair in normal temperature to prevent reformation so that it keeps its performances for long period.
- Clean the wheelchair with a clear and soft cloth and dry it. Never use any chemicals to clean it.(to prevent reformation and discoloration).
- Remove the cloth cover of the seatback to be washed if it is dirty, and then dry it for use.

9.1.5 Routine Checks

Inspection Items	At any time	Weekly	Monthly	Six monthly
All parts			○	
Joystick function	○			
Brake System	○			
Connection		○		
Battery Condition	○			
Tire Condition			○	
Frame Condition				○
Front Wheel Condition		○		
Pureness	○			

9.1.6 Cleaning

- Never wash your wheelchair with water or expose directly to water.
- Surface of wheelchair frame is coated with a protective coating. Therefore, it is very easy to wipe it clean with a damp cloth. Never use any chemicals to clean the vinylon seat and armrest, as they may cause the latter slip or chapped. You can use a damp cloth and neutral soapy water to clean them, and then dry thoroughly.

9.2 Troubleshooting: Refer to manual 7.Fault Diagnosis and Troubleshooting.

10. Transportation and storage

10.1 Transportation

You can load and transport according to the shipping marks and graphics. For details, see the attachment.

VII. WARRANTY

10.2 Storage

Your wheelchair should be stored in a dry condition free from sources of extreme temperature and dampness. Remove the batteries from the wheelchair prior to storage. Otherwise, the frame may be rusted and the electronics may be damaged.

11. Opening and checking

Attached the packing list in the packing box. You can check whether there is any missing or damage.

No.	Name	Quantity	Remark
1	Electric Wheelchair	1pc	Model:N5513
2	Charger	1pc	Model: HP0060WL2/ 60HZ 24V2A
3	Instruction Manual	1pc	

12. Quality Assurance

12.1 Warranty

12.2.1 Chair frame will have 5 years warranty service.

12.2.2 Within 1 year from the purchase date, for the following parts, we will supply free maintenance and replace service for original customer after the dealer has checked for material and production defects.

- Electrical control or lever system
- Motor/Drive System
- Bearing and shaft sleeve

12.2.3 Six-Months warranty for the batteries.

Please note the warranty service is provided by your dealer, and finally finished by our after-sales department and dealer together.

Out of warranty:

- ABS plastic cover shell and rubber pad
- Tires
- Interior decoration
- Damage by abuse, wrong operation, accidents and negligence
- Abnormal use

USA

182 Susquehanna Avenue
Exeter, PA 18643-2694
Canada
5096 South Service Road
Beamsville, Ontario L0R 1B3

Australia

20-24 Apollo Drive
Hallam, Victoria 3803
www.pridemobility.com.au

New Zealand

38 Lansford Crescent
Avondale
Auckland, New Zealand 1007
www.pridemobility.co.nz

UK

32 Wedgwood Road
Bicester, Oxfordshire OX26
4UL www.pride-mobility.co.uk

Germany

Pride GmbH
Hövelrieger Str. 28
33161 Hövelhof
Germany

The Netherlands
De Zwaan 3
1601 MS Enkhuizen
www.pridemobility.eu

Italy

Via del Progresso, ang. Via deL
Lavoro Loc. Prato della Corte
00065 Fiano Romano (RM)
www.pride-italia.it

France

26 rue Monseigneur Ancel
69 800 Saint-Priest
www.pridemobility.fr

Spain

Calle Velazquez 80 6D
28001 Madrid
www.pridemobility.com

EU Representative

SUNGO Europe B.V.
Fascinatio Boulevard 522,
Unit 1.7, 2909VA
Capelle aan den IJssel,
The Netherlands

Serial number: